



Contract Furniture *and* Interiors



# CONTENT

---



- 4 CHROMATYX Color Printing
- 6 CARVED BY CALYX Acoustic Patterns
- 7 OMBRIA Gradient Glass
- 8 CALYX GLASS Markerboard -  
Magnetic, Non-Magnetic, Non-Glare
- 10 PROFILE Porcelain Markerboard
- 11 CONCEPT Wall-Mounted Board
- 12 CURSIVE Wall-Mounted Markerboard
- 14 RAVINA Wall-Mounted Markerboard
- 16 MINA Mobile & Space Creator
- 18 SWITCH Wall-Mounted Board
- 20 SWITCH Mobile Board
- 22 VENUE Collection -  
Markerboard, Mobile Board, Space Divider
- 26 ACENO Collection
- 28 NIMBUS Multi-Purpose Mobile
- 29 EDIFY Mobile Board
- 30 TRAVERSE Mobile Board
- 32 MIX Contemporary Wall-Mounted Board
- 33 MIX Industrial Wall-Mounted Board
- 34 MIX Contemporary Mobile Board
- 36 MIX Industrial Mobile Board
- 38 MIX Biophilic Mobile
- 39 MIDAIR Mobile Board
- 40 CONNECT X2 Wall-Mounted Board -  
Markerboard, Tackboard, Modular System
- 42 CONNECT X2 Mobile Board
- 44 CONNECT X2 Space Creator
- 46 MOTIF Markerboards and Tackboard
- 47 Tack Wall
- 48 Large Format Glass Marker Wall System
- 49 Large Format Porcelain Marker Wall System
- 50 CADENCE Blended Wall System
- 52 FLIPWRITE Patient Board
- 53 ENVISION Board
- 54 EVOLVE Markerboard and Tackboard
- 55 EVOLVE Sliding System
- 56 TRAK-IT Sliding System
- 57 Horizontal Sliding Board System
- 58 Accessories
- 60 Ombria Gradient Colors
- 61 Calyx Glass and LCS Porcelain Colors  
Trim Colors
- 62 Calyx Acoustic Colors and Finishes
- 63 Materials

# WRITING SURFACES & APPLICATIONS

---

A dry erase whiteboard's effectiveness as a communication tool is only as good as its writing surface, which is the primary medium for exchanging visual information. Not all writing surfaces are equal, and the quality and composition of the material used to make them directly affect the user experience.

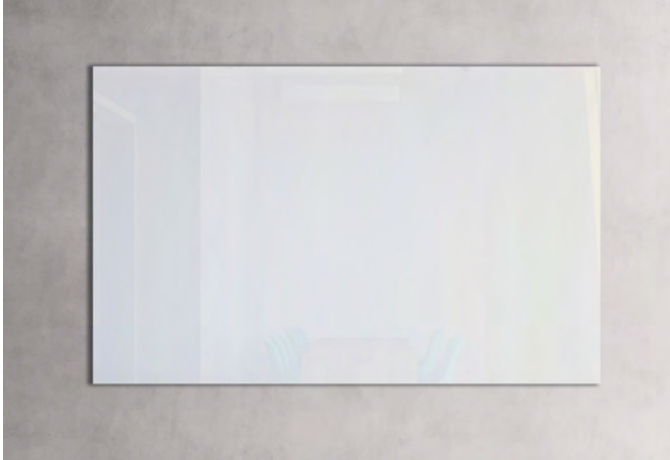

*Invisi-Mount Calyx Glass Markerboard*

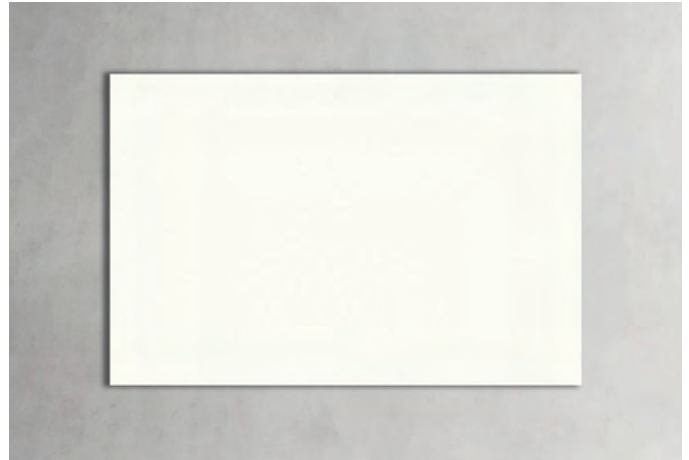

*Profile LCS Porcelain Markerboard*

## CALYX GLASS

- Unlimited Color Options
- 
- Customizable Printed Graphics
- 
- Erases Well, Easy to Clean
- 
- Stylish, Endless Design
- 
- Works with Rare Earth Magnets
- 
- Non-porous surface makes it naturally bacteria resistant and easily cleanable
- 
- SCS Indoor Advantage Gold Certified

## LCS PORCELAIN

- White, Light Gray, Bone, Black Color Options
- 
- Life of Building Warranty
- 
- Projection Friendly
- 
- Scratch and Stain Resistant
- 
- Works with Magnets
- 
- Non-porous surface makes it naturally bacteria resistant and easily cleanable
- 
- SCS Indoor Advantage Gold Certified and Cradle-to-Cradle Certified

## APPLICATIONS

Custom graphics, unlimited colors and layered textures are offered to engage and explore the art of collaboration with eye-catching design and elevated functionality.

**Calyx Chromatyx** - digital color printing on three surfaces—porcelain, glass, and acoustic

**Ombria** - gradient color printing on glass surfaces

**Carved by Calyx** - carved through or embossed patterns on acoustic surfaces

## CALYX CHROMATYX - GLASS



 [View Product Online](#)

Functional art on walls with full digital color printing capability

## CALYX CHROMATYX – PORCELAIN

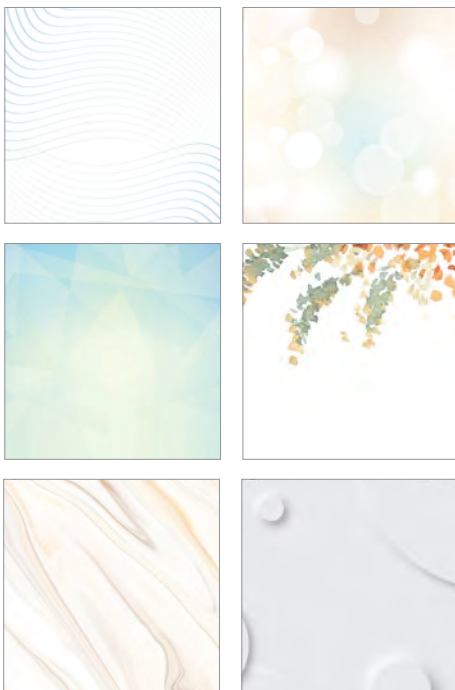

### FEATURES

- Full color digital printing on glass, porcelain, or acoustic
- Standard white porcelain with design patterns available
- Choose from a variety of print locations for your graphic or choose “full board” to create a print that covers the entire surface. Perfect for art or photos.
- Landscape and portrait orientations available
- Writing surface accepts magnetic accessories
- Size up to 4' x 8' (porcelain width is 1/8" smaller)

Standard porcelain design options

# CARVED BY CALYX



 [View Product Online](#)

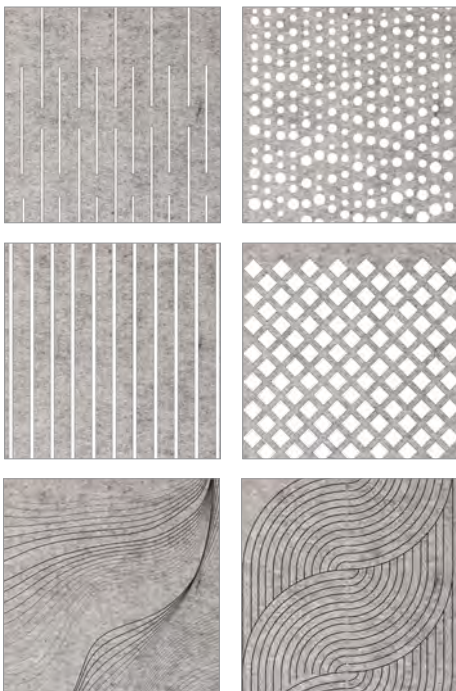

## FEATURES

- Precision digital cutting on acoustic surfaces
- Standard carved design patterns or custom designs available
- Multi-layering depth cuts or cut through options
- Landscape and portrait orientations available
- Acoustic Panel is available in 5 standard plus 19 additional colors for order - see page 62 for color options
- Size up to 4' x 8'

*Partial standard acoustic patterns*



 [View Product Online](#)



*\*Ombria Glass with transparency does not accept magnetic accessories*

## FEATURES

- Choose one, two, or three color gradients to create an art piece that is useful for collaboration
- Choose from 50 standard preset gradient colors or create custom gradients - see page 60 for standard gradient colors
- \*Accepts magnetic accessories
- Ombria gradient can be applied to any glass panel - wall-mounted, mobile, or space creator

## CALYX GLASS MARKERBOARDS



 [View Product Online](#)

Stylish, functional and easy to maintain glass surface

# CALYX GLASS MARKERBOARDS

## FEATURES

- Silky smooth surface writes easily, erases cleanly – no ghosting
- 1/4" tempered low-iron, CalyxClear glass
- Select from mounting methods
  - Invisi-mount – no visible hardware; gives the appearance of a floating panel
  - Stand-off Edge or Through Glass Mount – attractive stainless steel finish
- Available in 10 standard colors and over 180 optional powder coat colors – see page 61 for standard glass colors
- Standard sizes range from 2' x 3' up to 5' x 10' and 4' x 12'
- Custom logos, colors and sizes available
- Steel-backed glass doubles as magnetic surface
- Includes 4 rare earth magnets

## OPTIONS

- Non-Magnetic – available with Stand-off Edge or Through Glass Mounts
- Non-Glare – Satin, velvety surface provides minimal distractions from glare and reflections



Standoff Through Glass Mount Whiteboard



Edge Mount Glass Whiteboard

## Mounting Options

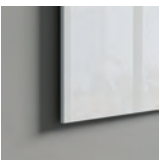

Invisi-Mount



Standoff Edge Mount



Standoff Through Mount

## PROFILE MARKERBOARDS



 [View Product Online](#)

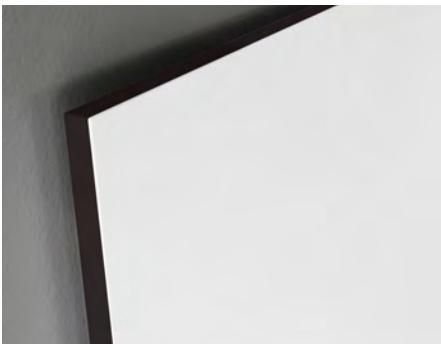

*Profile Detail with Calyx Edge*

### FEATURES

- Projection friendly, smooth writing surface writes easily, erases cleanly – no ghosting
- Available in LCS Porcelain dry erase whiteboard, chalkboard or marker wall – see page 61 for color options
- Optional Calyx Edge painted in 10 standard colors for added edge accent – see page 31 for color options
- No visible hardware; gives the appearance of a floating panel
- Accepts magnetic accessories
- Available in sizes up to 5' x 8'
- Lifetime warranty

A cost effective alternative to frameless glass whiteboards



 [View Product Online](#)



Tackboard



Marker Tray (standard)

**FEATURES**

- 5/16" aluminum trim profile with eased edge - available with marker or tack board
- For longer lengths, ask about Concept Connected; boards are joined on site with a narrow H-bar or spline
- Whiteboards - Projection friendly Low Gloss White LCS Porcelain enamel steel
- Tackboards - Carnegie, Guilford or Maharam fabrics, Calyx Cork or COM
- Aluminum frame in clear anodized finish comes with or without full length marker tray

**STANDARD SIZES (HxW):**

2' x 3'	4' x 4'	5' x 6'
3' x 4'	4' x 5'	5' x 8'
	4' x 6'	5' x 10'
	4' x 8'	5' x 12'
	4' x 10'	
	4' x 12'	

# CURSIVE BOARDS



## FEATURES

- Combination of our best in class writing surfaces and tack surfaces
- Stylish curved corners
- Writing Surfaces: LCS Porcelain – 7 standard colors or Calyx Glass – 10 standard glass colors – see page 61 for color options
- Calyx Acoustic tackable pads in 5 standard plus 19 additional colors for order – see page 62 for color options
- Maharam tackable fabric in 20 standard colors – see page 63 for color options

## STANDARD SIZES (HxW)

36" x 12"  
36" x 24"  
36" x 48"  
48" x 12"  
48" x 24"  
48" x 48"  
48" x 60"  
48" x 72"



 [View Product Online](#)



**FEATURES**

- Single panel surface with soft rounded corners
- Writing surfaces available in Calyx Glass and LCS Porcelain - accepts magnetic accessories
- Tackable surfaces available in Calyx Acoustic and Maharam fabric

**STANDARD SIZES (HxW)**

- 24" x 36"
- 36" x 48"
- 48" x 48"
- 48" x 60"
- 48" x 72"
- 48" x 96"

*Note: LCS Porcelain, Calyx Acoustic, and fabric wrapped boards are 1/2" smaller, and Calyx Glass is 1/4" smaller on all standard sizes.*

## RAVINA BOARDS



 [View Product Online](#)

Framed writable or tackable wallboard with a stylish reveal



*Trim and reveal gap detail*

### FEATURES

- Stylish 5/16" reveal gap between the trim and the perimeter of the board
- 5/16" face trim and 1" depth
- Writing surfaces available in Calyx Glass and LCS Porcelain - see page 61 for color options
- Ombria gradients on glass available - see page 60 for color options
- Writing surfaces accept magnetic accessories
- Tackable surfaces are fabric wrapped and available in Maharam, Guilford, and Carnegie fabrics - see page 63 for color options
- Trim comes available in responsibly harvested Ash wood or clear anodized aluminum with option to powder coat in 24 standard colors or 180 additional colors
- Ash wood is available in Clear, Vellum, Driftwood, and Rustic stains

### STANDARD SIZES (HxW)

24" x 36"

36" x 48"

48" x 48"

48" x 60"

48" x 72"

48" x 96"

## MINA COLLECTION



 [View Product Online](#)

Frameless minimalist style mobile and space creator designed for the modern workspace

## MINA MOBILES & SPACE CREATORS



Foot Detail

### FEATURES

- Panels are double sided with option to choose from both writing or tack surfaces
- Writing surface available in Calyx Glass magnetic or non-magnetic, LCS Porcelain or LCS Chalk - see page 61 for color options
- Ombria gradients on glass available - see page 60 for color options
- Tackable surface available in Calyx Acoustic or designer fabrics in Maharam, Guilford, or Carnegie - see page 62 and 63 for color options
- Sturdy steel feet are available in 24 standard gloss or 10 matte colors, 180 optional colors, and unlimited custom colors
- Mobile comes with 2 locking and 2 non-locking casters
- 4 units can nest within a 24.5" footprint depth

### STANDARD SIZES

H 60", 72"   W 36", 42"   D 21"

## SWITCH COLLECTION



 [View Product Online](#)

The slim trim elements give the board a minimalistic quality

## SWITCH WALL-MOUNTED BOARDS



### FEATURES

- Switch Boards are designed to be functionally agile; providing a writable surface and optional tackable pads that can be moved and configured for collaborative use
- An integrated marker tray gives a pop of color along the bottom edge of the board
- Writing Surfaces: LCS Porcelain - 7 standard colors or Calyx Glass - 10 standard glass colors - see page 61 for color options
- Frame and marker tray available in 10 standard matte finish colors - see page 61 for color options
- TacPads available in Calyx Acoustic and fabrics in Carnegie, Maharam, and Guilford - see page 62-63 for color options

### STANDARD SIZES

H 3', 4' W 4', 5', 6', 8'

## SWITCH MOBILES



 [View Product Online](#)

Ideal for multi-use settings, most notably the ability to stack and store mobiles into a small footprint

## SWITCH MOBILES



### FEATURES

- An integrated marker tray gives a pop of color along the bottom edge of the board while mimicking the shape of the legs as it bends away from the writing surface
- The slim trim elements give the board a minimalistic quality
- Switch is designed to be functionally agile; providing an optional tackable surfaces that can be moved and configured for collaborative use
- Mobile boards can be easily nested and stowed away when not in use
- Comes with two (2) locking and two (2) non-locking Hubless Casters.
- Writing Surfaces: LCS Porcelain - 7 standard colors or Calyx Glass - 10 standard glass colors - see page 61 for color options
- Marker tray, frame and leg available in 10 standard matte finish colors - see page 61 for color options
- TacPads available in Calyx Acoustic and fabrics in Carnegie, Maharam, and Guilford - see page 62-63 for color options

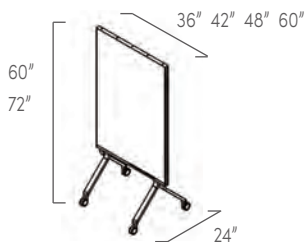

### STANDARD SIZES

H 60", 72" W 36", 42", 48", 60" D 24"

## VENUE COLLECTION



Stylish frame and distinctive angled marker tray enhance a variety of aesthetics

## VENUE WALL-MOUNTED BOARDS



 [View Product Online](#)



### FEATURES

- The stylish frame and distinctive angled marker tray available in 10 standard matte finish colors - see page 61 for color options
- Available in 8 standard sizes, custom sizes available
- Writing Surfaces: LCS Porcelain - 7 standard colors or Calyx Glass - 10 standard glass colors - see page 61 for color options

### STANDARD SIZES

H 3', 4' W 4', 5', 6', 8'

# VENUE MOBILES



Venue V-Leg Mobile



Venue T-Leg Mobile

## FEATURES

- **V-Leg Mobile:** upright design with board surface starting approximately 18" from the floor, slightly more approachable; comes with two (2) locking and two (2) non-locking Hubless Casters
- **T-Leg Mobile:** lower profile design with board surface starting approximately 10" from the floor, convenient nesting - available in full or split panels and comes with two (2) locking and two (2) non-locking Hubless Casters
- **T-3 Leg Mobile:** board surface starting approximately 10" from the floor, convenient for tight spaces - comes with two (2) locking and one (1) non-locking Hubless Casters
- **Writing Surfaces:** LCS Porcelain - 7 standard colors or Calyx Glass - 10 standard glass colors - see page 61 for color options
- **Trim** available in 10 standard matte finish colors - see page 61 for color options
- **TacPads** available in Calyx Acoustic and fabrics in Carnegie, Maharam, and Guilford - see page 62-63 for color options

## STANDARD SIZES

H 60", 72"    W 36", 42", 48", 60"    D 24"

 [View Product Online](#)

### V-LEG MOBILE



V-Leg: 18" board to floor

### T-LEG MOBILE

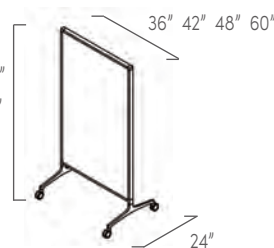

T-Leg: 10" board to floor

### T-LEG SPLIT 75/25 MOBILE



### T-3 LEG MOBILE



# VENUE SPACE DIVIDERS

## FEATURES

- Flexible and adaptive room dividers provide a visual border to define space not only within the open environment but within systems themselves
- Create a boundary of space to define areas of collaboration and areas of concentration
- Divide personal space between benching seats and workstation clusters/packs
- Integrated textiles and perforated acoustic panels add another layer of privacy beyond the visual
- Split panels combine writable and tackable fabric surfaces in 25/75, 75/25, and 50/50 split options
- Writing Surfaces – LCS Porcelain – 7 standard colors or Calyx Glass – 10 standard glass colors – see page 61 for color options
- Tackable Surfaces – Carnegie, Maharam, or Guilford materials available – see page 63 for color options
- Trim available in 10 standard matte finish colors – see page 61 for color options

## STANDARD SIZES

H 48", 60", 72" W 36", 48" D 15"



 [View Product Online](#)

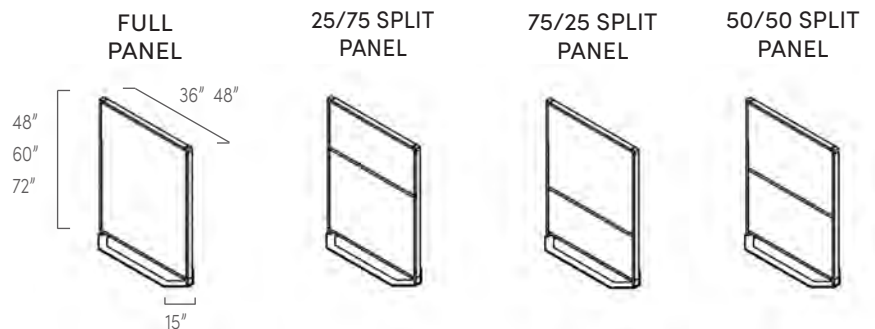

## ACENO COLLECTION



 [View Product Online](#)

Flexible solution for today's collaborative workspaces. Lightweight panels easily move from the wall track system, to a stylish room divider, to a beautiful cart.

# ACENO COLLECTION

## FEATURES

### Room Divider

- Stylish, steady base in standard or custom colors
- CIS writing surface with Calyx Acoustic reveal on both sides
- CIS writing surface comes in standard white
- Panel core is available in Calyx Acoustic - 5 standard plus 19 additional colors for order - see page 62 for color options

### Track Wall System

- Wall track system available with optional back panel in Calyx Glass or LCS porcelain; no back panel required for functionality
- Track is available in 10 standard matte finish colors - see page 61 for color options

### Storage Cart

- Panels placed on each side for use as a mobile markerboard
- Cart can store up to 8 panels
- Solid wood frame
- Comes with two locking and two non-locking casters
- Circular cutout handles for ease of mobility

## PANEL SIZES (HxW)

48" x 28"

48" x 36"

55" x 28"

55" x 36"

68" x 28"

68" x 36"

## TRACK SYSTEM - WIDTH SIZES

48", 72", 96"

## CART SIZE (HxWxD)

45" x 40" x 21"



Aceno Wall Track System



Aceno Storage Cart

## NIMBUS MULTI-PURPOSE MOBILE



 [View Product Online](#)

### FEATURES

- Beautiful solution for room division
- Side panels fitted with LCS Porcelain writing surface, acoustic, tack surface, or a combination of surfaces
- Center shelves accessible from both sides
- Cord management access on back of shelves
- Solid wood frame
- Comes with two locking and two non-locking casters

### SIZE (HxWxD)

60" x 40" x 19"



 View Product Online

**FEATURES**

- Sturdy steel frame with tray, optional bin or shelf available in vibrant color options
- LCS (Lifetime Ceramic Surface) Porcelain writing surface
- Standard height is 72" from the floor
- Frame, tray, bin, and shelf available in 6 suggested standard color options - choose 1 or 2 colors - see page 61 for color options
- Comes with two locking and two non-locking casters

**STANDARD SIZES**

H 72" W 36", 48" D 21 -1/4"

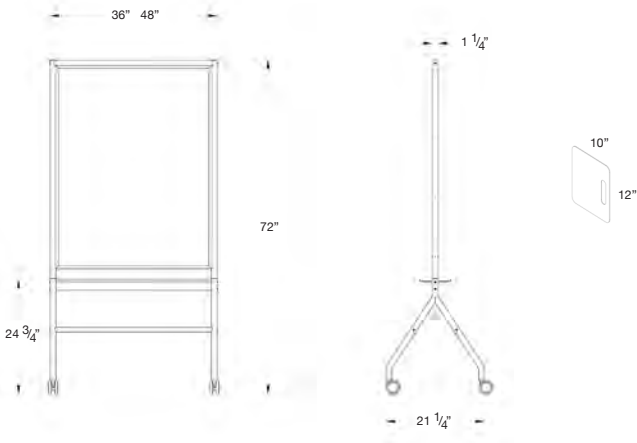

## TRAVERSE INDOOR/OUTDOOR MOBILE



 [View Product Online](#)

Built to move seamlessly from indoor spaces to outdoor settings, giving you the freedom to collaborate anywhere.

# TRAVERSE INDOOR/OUTDOOR MOBILE



## FEATURES

- Weather and insect resistant writing surface - LCS Porcelain with Calyx Core's non-porous properties stand up to the elements for reliable performance indoors or outdoors
- All-terrain mobility - durable casters (two locking, two non-locking) to roll smoothly over any surface
- Sturdy steel frame with perforated trays for proper water drainage—engineered for both function and resilience
- Available in 10 vibrant standard color options for frames and trays to complement any environment

## STANDARD SIZES

H 76" W 36", 48"



## Standard Colors

Applicable to Traverse and Calyx Edge



Lemon Yellow Pure Orange Ruby Red Signal Green Signal Blue



\*White \*Black \*Bronze \*Slate Grey Agate Grey

\* Matte colors

# MIX | CONTEMPORARY WALL-MOUNTED BOARDS

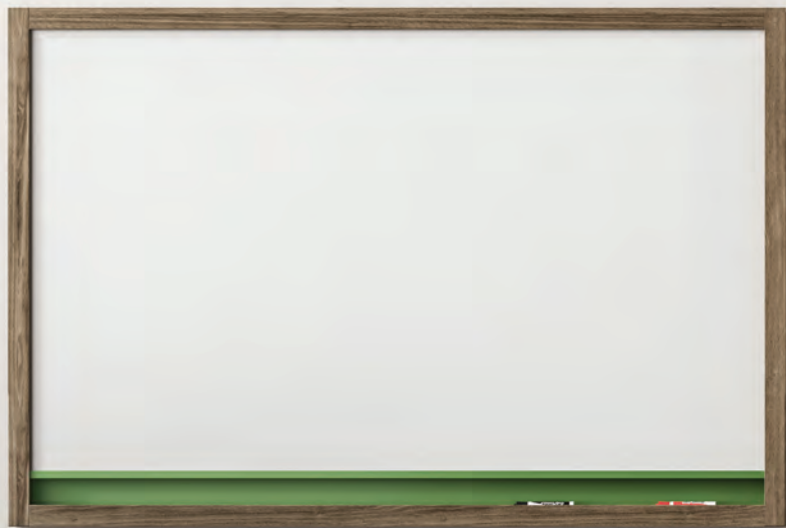

 [View Product Online](#)

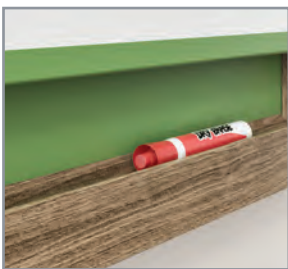

## FEATURES

- MIX Contemporary Wall-Mounted Boards are companions to the Contemporary Mobiles
- Available in Calyx Glass and LCS Porcelain writing surfaces or Calyx Cork tack surface
- Metal accent strip highlights the integrated marker rail available in 180 powder coat colors
- Responsibly harvested Ash wood frame available in Clear, Vellum, Driftwood, and Rustic stains - see page 62 for MIX color options

## STANDARD SIZES (HxW)

3' x 4'    4' x 3'  
3' x 5'    4' x 4'  
            4' x 6'  
            4' x 8'

# MIX | INDUSTRIAL WALL-MOUNTED BOARDS



 [View Product Online](#)



## FEATURES

- MIX Industrial Wall-Mounted Boards are companions to the Industrial Mobiles
- Available in Calyx Glass and LCS Porcelain writing surfaces or Calyx Cork tack surface
- Metal accent strip highlights the integrated marker rail available in matte black or 180 optional powder coat colors - see page 62 for MIX color options
- Responsibly harvested Ash wood frame available in Clear, Vellum, Driftwood, and Rustic stains
- Industrial Markerboards come with metal corner accents with exposed hex bolts in matte clear finish

## STANDARD SIZES (HxW)

3' x 4'    4' x 3'  
3' x 5'    4' x 4'  
            4' x 6'  
            4' x 8'

MIX | CONTEMPORARY MOBILE BOARDS



 [View Product Online](#)

Choose your expression

# MIX | CONTEMPORARY MOBILE BOARDS

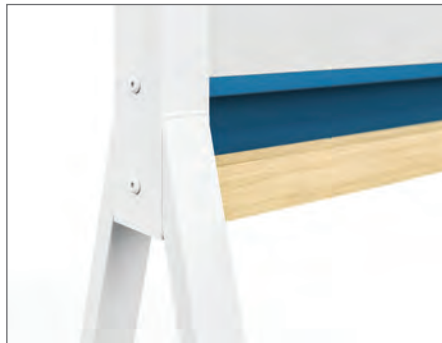

## FEATURES

- Available in Calyx Glass and LCS Porcelain writing surfaces or Calyx Cork tack surface
- Responsibly harvested Ash wood frame available in Clear, Vellum, Driftwood, and Rustic stains
- Metal bases and accent strips available in Signal White, Slate Grey or Matte Black with 180 optional powder coat colors – see page 62 for MIX color options
- Optional metal shelf to match the base (partial height only)
- Mobiles come with hubless casters

## AVAILABLE SIZES (HxW)

Partial Height	Full Height
72" x 36"	72" x 36"
72" x 48"	72" x 42"
72" x 60"	72" x 48"
*72" x 72"	**72" x 60"

*\*Available for Calyx LCS Porcelain and LCS Porcelain/Cork only*

*\*\*Available for Calyx LCS Porcelain only*



 [View Product Online](#)

Customizable components – from Ash wood stains, accent strip and metal base colors to best in class writing surfaces

# MIX | INDUSTRIAL MOBILE BOARDS



## FEATURES

- Available in Calyx Glass and LCS Porcelain writing surfaces or Calyx Cork tack surface
- Metal accent strip highlights the integrated marker rail available in matte black or 180 optional powder coat colors - see page 62 for MIX color options
- Responsibly harvested Ash wood frame available in Clear, Vellum, Driftwood, and Rustic stains
- Metal bases come with exposed hex bolts in matte clear finish
- Optional metal shelf to match the base (partial height only)
- Industrial casters include exposed brake locks

## AVAILABLE SIZES (HxW)

Partial Height	Full Height
72" x 36"	72" x 36"
72" x 48"	72" x 42"
72" x 60"	72" x 48"
*72" x 72"	**72" x 60"

*\*Available for Calyx LCS Porcelain and LCS Porcelain/Cork only*

*\*\*Available for Calyx LCS Porcelain only*



 [View Product Online](#)



Serenity



Om

## FEATURES

- Available on Contemporary or Industrial mobiles - see page 62 for MIX color options
- Biophilic panels retain their vibrant, fresh-cut look for 10+ years, giving designers a creative, long-lasting option for nature-themed interiors
- These all natural preserved plants do not require water, sunlight, soil, misting or irrigation
- Choose from two standard designs - Serenity and Om; custom designs available upon request
- Numerous credit contributions for LEED® v4 projects (BD+C, ID+C, O+M)
- Wall garden installations have significant noise reduction coefficient (NRC)
- Conforms to requirements within the WELL Building Standard™ and the Healthy Hospital Initiative (HHI)

## AVAILABLE SIZES

Standard size 72" x 42" fits on Contemporary or Industrial full height mobiles. Custom sizes available.

## MIDAIR MOBILE BOARDS



 [View Product Online](#)

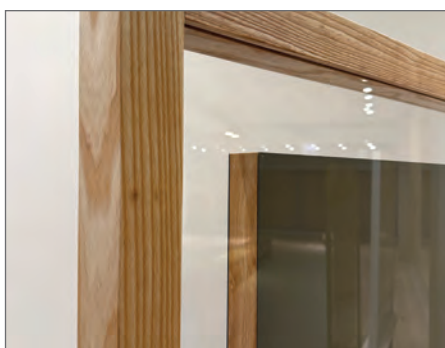

### FEATURES

- Clear low-iron tempered glass with center magnetic writing surface printed in unlimited solid colors, Ombria colors, or custom graphics
- Inner center glass edged with wood
- Responsibly harvested Ash wood frame available in Clear, Vellum, Driftwood, and Rustic stains - see page 62 for wood finish options
- Metal bases and accent strips available in 24 standard colors, over 180 powder coat colors, and unlimited custom colors - see page 61 for color options.
- Optional metal shelf to match the base
- Mobiles come with hubless casters

### AVAILABLE SIZES (HxW) - in partial or full height

72" x 36"

72" x 48"

72" x 60"

CONNECT  X2 WALL-MOUNTED BOARDS



*X2 Markerboard*

 [View Product Online](#)

The slim trim elements give the board a minimalistic quality

## CONNECT X2 WALL-MOUNTED BOARDS



X2 Tackboard



X2 Modular System

### FEATURES

- Narrow 1/4" clear anodized aluminum trim profile with eased edge
- Available in Calyx Glass or LCS Porcelain markerboard, tackboard or modular system – combining writing and tack surface in multiple groups and unlimited configurations
- Clear anodized trim can be powder coated in 24 standard colors, 180 optional colors, and unlimited custom colors – see page 61 for color options
- Available with optional fixed marker tray or magnetic tray
- Trim available with or without reveal
- Tackboard surfaces available in Calyx Cork, Guilford, Carnegie, Maharam or pre-approved COM fabrics – see page 63 for color options

### STANDARD SIZES (HxW):

1.5' x 2'	4' x 4'
2' x 3'	4' x 6'
3' x 4'	4' x 8'



No reveal



With reveal



 [View Product Online](#)

Easy to move with flexible display and presentation solutions while preserving floor and work space

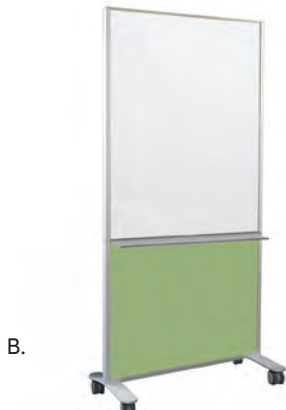

**FEATURES**

- Available with any combination of markerboard or tackboard
- Mobiles are 72" high
- Calyx Glass and LCS Porcelain mobiles available in widths 30", 36", 42", 48", and 60" for full height (A) only
- Markerboard/Tackboard combination (B); Partial height (C); and 3 caster mobiles (D) available in two widths: 36" and 48"
- Full height, open or tackable panel at the bottom
- Locking casters
- Optional ganging mechanism
- Custom sizes available



A. Full height mobile markerboard in Calyx Glass or LCS Porcelain (X2-MM)

B. Combination mobile - top panel in Calyx Glass or LCS Porcelain; and bottom tack panel (X2-MMNT)

C. Partial height mobile (X2-MMN); not available with glass writing surface

D. 3-Caster mobile (X2-MM3); not available with glass writing surface



 [View Product Online](#)

A functional, movable environment that can be reconfigured for privacy and individual needs



Customize panel size, material and color.  
Panels can be markerboard, tackboard or combination of both.

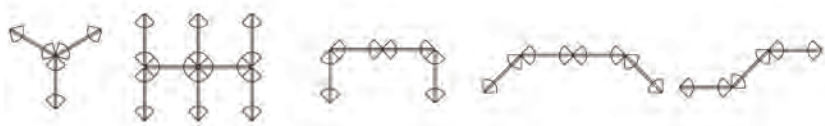

Unlimited configurations

#### FEATURES

- Stand alone or group together; simple ganging mechanism included
- Select from one to four tiles
- Panels extend fully to the floor for complete privacy
- Low profile foot provides stability
- Markerboard in LCS Porcelain
- Tackboards in Calyx Cork, Guilford, Carnegie, Maharam or approved COM fabrics - see page 63 for color options

#### STANDARD SIZES (HxW):

- 72" x 30"
- 72" x 36"
- 72" x 48"

## MOTIF WALL-MOUNTED BOARD



 [View Product Online](#)

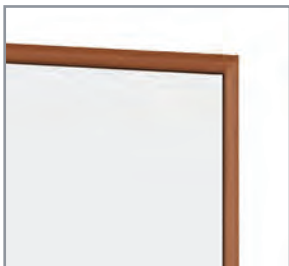

Wood Trim



Tackboard Surface

### FEATURES

- Rounded edge profile with a narrow face trim - available with marker or tack board
- Whiteboards - Projection friendly Low Gloss White LCS Porcelain enamel steel
- Tackboards - Carnegie, Guilford or Maharam Fabrics, Calyx Cork or COM
- Custom finishes available

### STANDARD SIZES (HxW):

- 2' x 3'
- 3' x 4'
- 4' x 4'
- 4' x 6'
- 4' x 8'

## TACK WALLS



 [View Product Online](#)

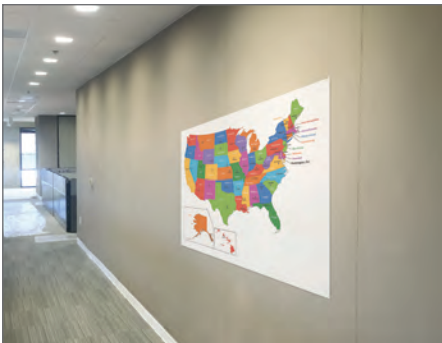

### FEATURES

- Cover an entire wall, floor to ceiling up to 10'
- Ideal for offices, board rooms, conference rooms, etc.
- Choose from Guilford, Carnegie and Maharam fabrics; Calyx Cork, custom colors or COM fabrics - see page 63 for color options

## CALYX LARGE FORMAT GLASS MARKER SYSTEMS



 [View Product Online](#)



### FEATURES

- A large format magnetic glass system ideal for non-stop brainstorming and client presentations
- Low-iron tempered glass for exceptional clarity
- 10 standard colors; 180 optional colors, or custom match colors
- Panel heights up to 10' and widths up to 4'
- Narrow 1/4" satin anodized aluminum trim top and bottom
- Sizes beyond standard range require custom quote and installation services

## CALYX LARGE FORMAT PORCELAIN MARKER SYSTEMS



 [View Product Online](#)



### FEATURES

- A magnetic large format system for walls configured for your environment
- Projection friendly writing surface that won't ghost or stain
- Panel heights up to 10' and widths up to 4'
- 4 standard colors in white, black, light grey and bone
- 3/4" to 1-1/4" face perimeter trim in clear anodized finish
- Sizes beyond standard range require custom quote and installation services

## CADENCE WALL SYSTEM



 [View Product Online](#)

Multi-surface blended wall system to create your own custom functional wall art

## CADENCE WALL SYSTEM

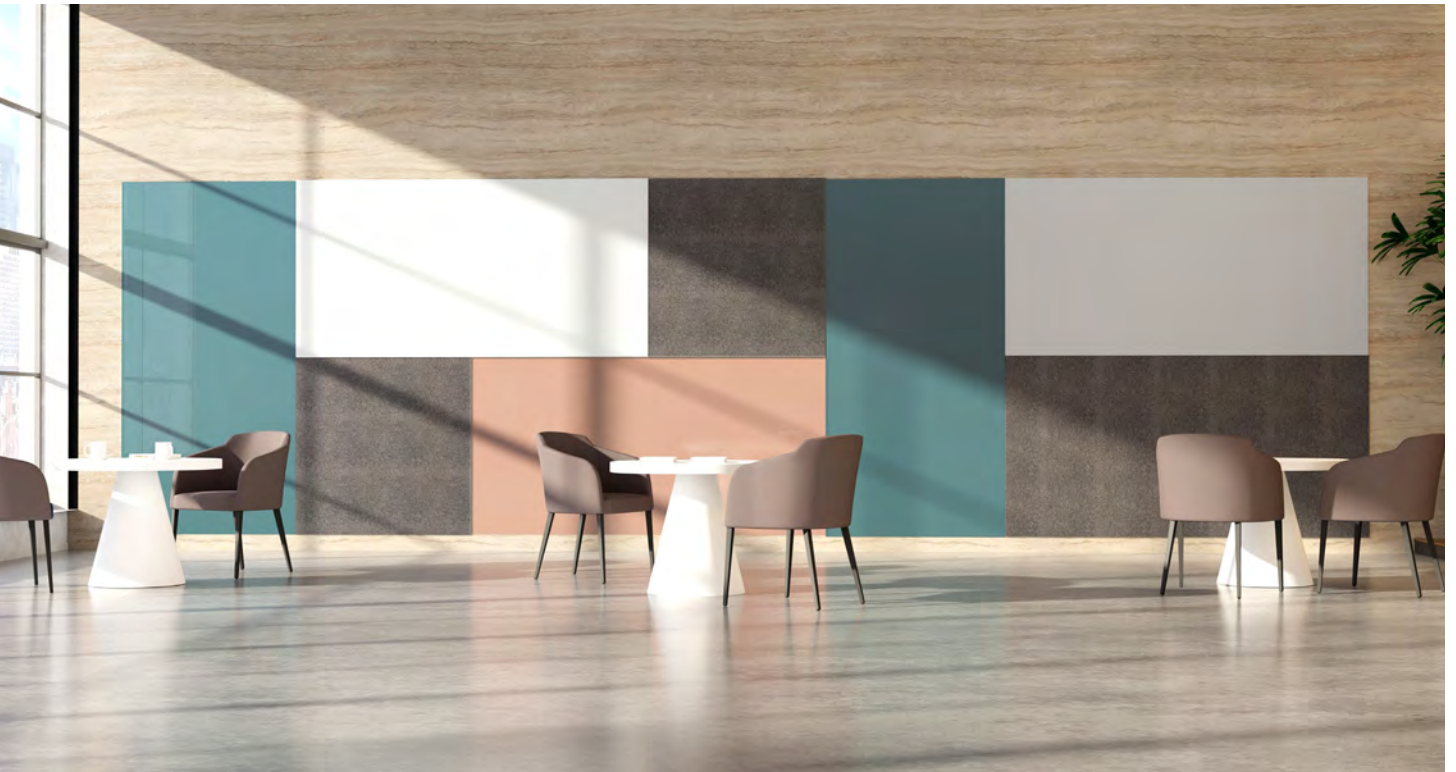

### FEATURES

- Choose from 3 surfaces: Calyx Glass, LCS Porcelain, and Calyx Acoustic
- 4 suggested configurations: Side-by-side panels, modular mixed panels, acoustic wrapped Calyx Glass, and acoustic wrapped LCS Porcelain
- Sizes up to 4' x 8'
- Optional Calyx Chromatyx printing to glass, porcelain or acoustic surfaces; Ombria gradients available for glass, standard designs available for porcelain
- Optional Carved by Calyx patterns to acoustic surfaces, standard or custom available
- Custom configurations and designs for Chromatyx or Carved available

# FLIPWRITE PATIENT BOARDS

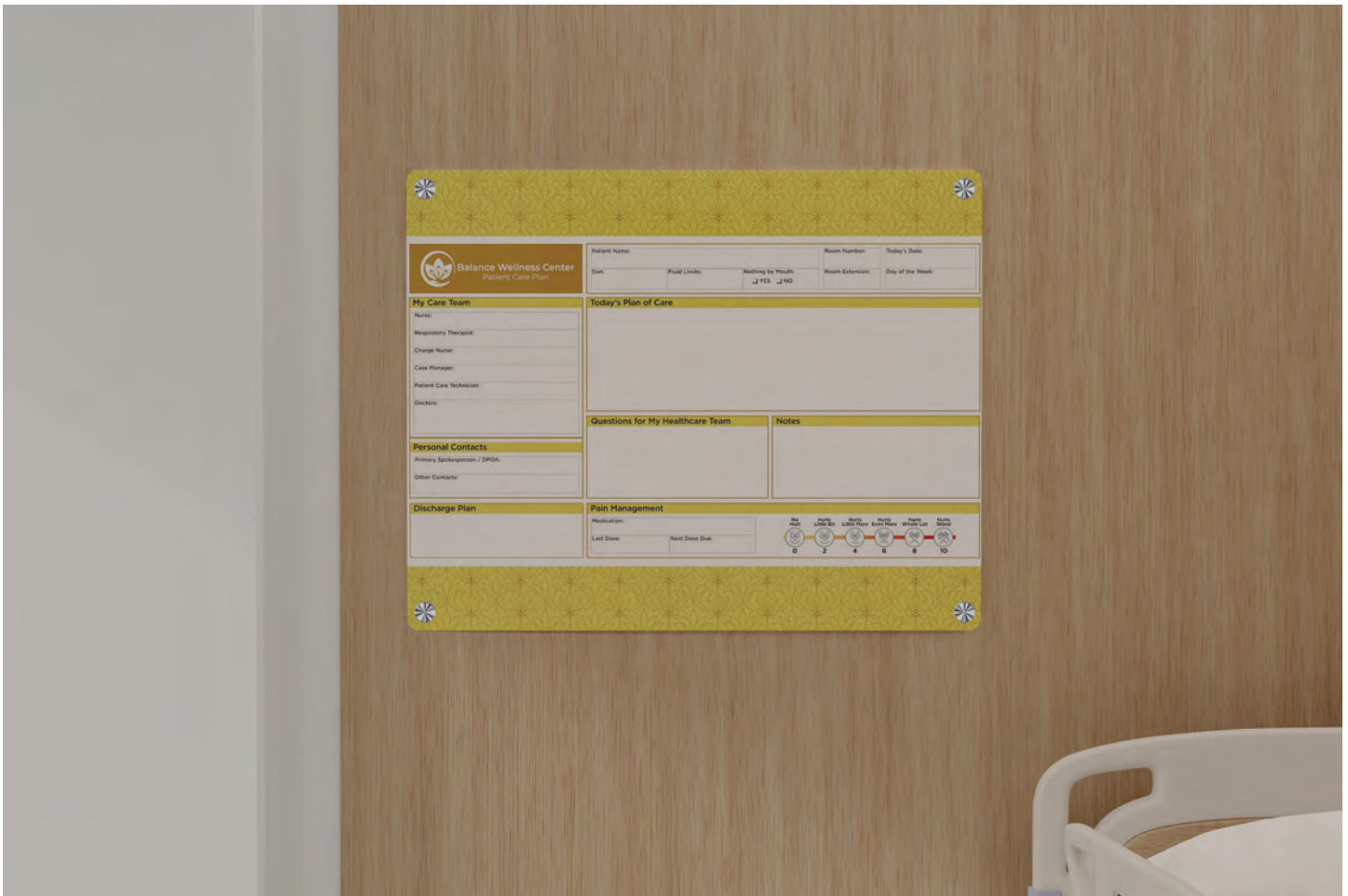

 [View Product Online](#)



## FEATURES

- Slide out and flip the two-sided custom printed graphic behind clear low-iron tempered glass surface for double communication function
- Custom printed design on glass top and bottom, and magnetic
- Aluminum stand-off through glass mounts

## STANDARD SIZES (HxW):

Available in horizontal or vertical format

- 12" x 16"
- 16" x 20"
- 18" x 24"
- 24" x 36"
- 36" x 48"

# ENVISION GRAPHIC BOARDS

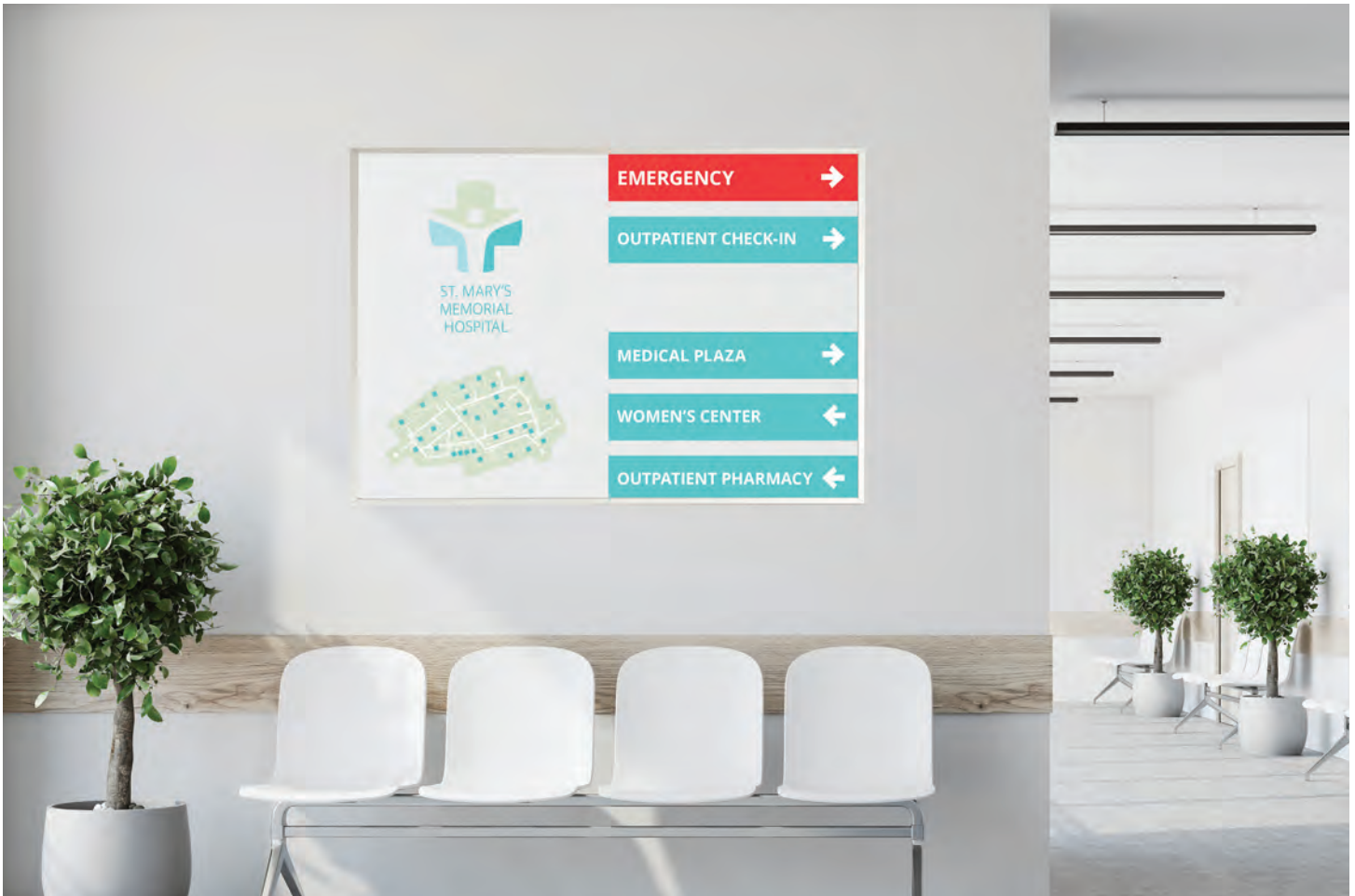

[View Product Online](#)



## FEATURES

- Dry-erase whiteboard surface with digitally printed graphics – photo quality images, logos, etc.
- Envision it: patient room boards, calendars, planners, performance tracking
- 3/8" aluminum frame comes standard in clear anodized finish, or choose from 180 optional powder coat colors
- Wood frames available in standard wood finishes or custom finishes

## STANDARD SIZES (HxW):

- 1.5' x 2'
- 2' x 3'
- 3' x 4'
- 4' x 4'
- 4' x 6'
- 4' x 8'

# EVOLVE WALL-MOUNTED BOARDS



 [View Product Online](#)



Accessory Tray

## FEATURES

- LCS Porcelain enamel steel writing surface in projection-friendly low gloss white
- Tackboards available in Guilford, Carnegie, Maharam, Calyx Cork or COM - see page 63 for color options
- Whiteboards available in 2', 3', and 4' heights, in widths up to 12'
- Wide face trim at top and bottom is 2 3/8"; narrow trim on the sides is 5/16"
- Snap-on tray can be easily added or removed

## MARKERBOARD STANDARD SIZES

2' x 3'	4' x 6'
3' x 4'	4' x 8'
4' x 4'	4' x 10'
4' x 5'	4' x 12'

## TACKBOARD STANDARD SIZES

4' x 4'	5' x 4'
4' x 6'	6' x 4'
4' x 8'	

## EVOLVE SLIDING SYSTEMS



 [View Product Online](#)



*Snap-on Tray*



*Sliding Panel*

### FEATURES

- Sliding board can be added to a fixed wallboard to increase usable surfaces or to conceal/reveal information written on the board surface.
- Fixed whiteboard panel in sizes up to 4' x 8' and sliding panels in 3' and 4' widths
- Sliding panel moves smoothly on top and bottom rollers
- Snap-on tray furnished with sliding panel

### STANDARD SIZES (HxW)

#### Fixed Markerboard:

4' x 4'    4' x 8'  
4' x 5'    4' x 10'  
4' x 6'    4' x 12'

#### Sliding Panel:

4' x 3'  
4' x 4'

## TRAK-IT SLIDING BOARD SYSTEMS



 [View Product Online](#)



### FEATURES

- Double-sided panels multiply communication space
- Panels, available in sizes up to 3' x 4', hang landscape or portrait
- Boards can be positioned anywhere along track
- Trak-It rail comes in 10' lengths
- Easy to rearrange – swing out, lift up
- Available in LCS Porcelain markerboard or tackboard surface
- Magnetic marker tray optional

### STANDARD SIZES (HxW)

2' x 3'

3' x 4'

## HORIZONTAL SLIDING BOARD SYSTEMS



 [View Product Online](#)



Custom-built to meet your needs, providing optimum display surfaces within easy reach







### FEATURES

- Sliding panels are top-suspended and glide easily over aluminum track on molded nylon roller
- Fixed back panels with 2, 3, or 4 sliding panels on 2, 3, or 4 tracks
- Sliding panels and back panels available in LCS Porcelain markerboard, chalkboard, or Calyx Glass writing surfaces
- Tackboard surfaces available in Calyx Cork or Guilford, Carnegie and Maharam fabrics - see page 63 for color options
- Writing surfaces double as magnetic surface
- Resists humidity and fading
- Heavy-duty aluminum housing, trim and panel edging are extruded aluminum with clear anodized finish

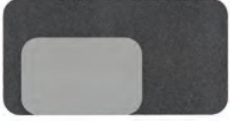
## ACCESSORIES

ITEMS	PRODUCT CODE	SIZE	DESCRIPTION
<b>Rare Earth Magnets</b>			
	MGM-REMSQ -B, -W, -G	1.29"h x 1.29"w	.44" thick, rounded corners, available in black, gray or white
<b>Slim Marker Caddy</b>			
	M-MC2 M-MC2P	1 3/8"h, 9"w, 1 3/8"d	Lightweight clear anodized aluminum, holds 4 markers with 3/4" diameter Optional powder coat color available
<b>Stadium Marker Caddy</b>			
	MGM-MC1-S MGM-MC1-M MGM-MC1-L	3 1/2"h, 3 1/8"w, 1 3/4"d 4"h, 4 1/2"w, 2 1/5"d 4"h, 8 1/2"w, 2 2/5"d	Small plastic magnetic holder - up to 8 markers Medium magnetic holder - up to 14 markers Large magnetic holder with divider for up to 14 markers, cleaners and erasers
<b>Magnetic Marker Tray</b>			
	MGM-T1	1 1/2"h, 12"w, 3"d	Clear anodized aluminum tray with rare earth magnets for glass surface Fabric backed tray with eased corners
<b>Slim Magnetic Marker Tray</b>			
	267M1 267MG1 267MG1-P	1 1/2"h, 12"w, 2 1/2"d 1 1/2"h, 12"w, 2 1/2"d 1 1/2"h, 12"w, 2 1/2"d	Slim clear anodized aluminum, magnetic for porcelain surface Magnetic tray with rare earth magnets for glass surface Optional powder coat color available
<b>Magnetic Aluminum Tray</b>			
	264M1 264MP1	2 7/16"h, 12"w, 2 11/16"d 2 7/16"h, 12"w, 2 11/16"d	Clear anodized aluminum, magnetic for porcelain surface Optional powder coat color available
<b>Adhesive Backed Marker Tray</b>			
	GM-Tray-1	2 7/16"h, 12"w, 2 11/16"d	Clear anodized aluminum tray stays in place with double-sided tape and holds in one permanent location
<b>Magnetic Aluminum Accessory Tray</b>			
	AT-12-ALUM AT-12-ALUM-PC	12"w 12"w	Includes 2 extra strong magnets. For use on porcelain surface. Optional powder coat color available.
<b>Magnetic Wood Accessory Tray</b>			
	AT-12-WOOD	12"w	Includes 2 extra strong magnets. For use on porcelain surface.

## ACCESSORIES

ITEMS	PRODUCT CODE	SIZE	DESCRIPTION
<b>TacPad</b> 	GS-TP-1409	14" x 9" x .13"	Tackable surface in fabric or acoustic material with rounded corners.
	GS-TP-2714	27" x 14" x .13"	Rare earth magnetic backing. Available in 2 sizes.
	GS-TP-1409-EW	14" x 9" x .13"	Fabric wrapped
	GS-TP-2714-EW	27" x 14" x .13"	Fabric wrapped
<hr/>			
<b>Dry-Erase Markers</b> 	LCS673-4 LCS668-4	6.5" x .75" diameter	4 broad-tipped markers. One each: red, blue, green and black 4 broad-tipped markers and one microfiber cloth
<hr/>			
<b>Dry-Erase Cloth</b> 	ECM227E ECM227D	12" x 12"	Microfiber eraser cloth. Erases evenly with no smearing. 1 dozen microfiber eraser cloths
<hr/>			
<b>Magnetic Eraser</b> 	MGM-ME1	2 1/8"h, 4 1/2"w, 7/8"d	Black felt eraser with strong rare earth magnets
<hr/>			
<b>Markerboard Cleaner</b> 	LCS683	8 oz.	Cleans and restores markerboard surfaces
<hr/>			
<b>ACCESSORY FOR FURNITURE SYSTEMS</b>			
<b>Partition Panel Clip</b> 	80	2"	Two each spring steel clips to fit over the top of any 2" thick partitions. Small prongs fit underneath the board trim.
	80-3	3"	Two each spring steel clips to fit over the top of any 3" thick partitions. Small prongs fit underneath the board trim.
<hr/>			

# OMBRIA COLORS

## Standard Gradient Colors



Zest  
2 Tone



Storm  
2 Tone



Plum  
2 Tone



Terracotta  
2 Tone



Sage  
2 Tone



Brilliant White  
2 Tone



Calm White  
2 Tone



Light Ivory  
2 Tone



Telegrey  
2 Tone



Signal Grey  
2 Tone

## Optional Gradient Colors



Mist  
2 Tone



London Fog  
2 Tone

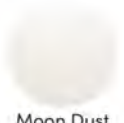

Moon Dust  
2 Tone



Champagne  
2 Tone



Coconut Cream  
2 Tone



Seaweed  
2 Tone



Caribbean  
3 Tone



Pebble  
3 Tone



Smolder  
2 Tone



Minimal Mint  
2 Tone



Primeval  
3 Tone



Winter Sky  
3 Tone



Acid  
3 Tone



Submarine  
2 Tone



Smoke  
3 Tone



Frozen Steel  
2 Tone



Antique Rose  
2 Tone



Mojave  
3 Tone



Terra  
3 Tone



Verdigris  
2 Tone



Still Water  
3 Tone



Lavender Haze  
3 Tone



Day Dream  
2 Tone



Blush  
3 Tone



Thicket  
3 Tone



Abyss  
3 Tone



Sherbet  
3 Tone



Deep End  
3 Tone



Brilliant White  
Transparent



Light Ivory  
Transparent



Signal Grey  
Transparent



Sage  
Transparent



Terracotta  
Transparent



Shirley  
2 Tone



Rose Petal  
3 Tone



Calm White  
Transparent



Telegrey  
Transparent



Plum  
Transparent



Storm  
Transparent



Zest  
Transparent



Custom  
Transparent

Custom gradients  
available

# COLORS

## Standard Glass Colors



\*Brilliant White    Telegrey 4    Signal Grey    Sage    Storm



Calm White    Light Ivory    Zest    Plum    Terracotta

\* Standard glass color comes in Brilliant White.  
Available in 180 optional colors and unlimited custom colors.

## LCS Porcelain Colors

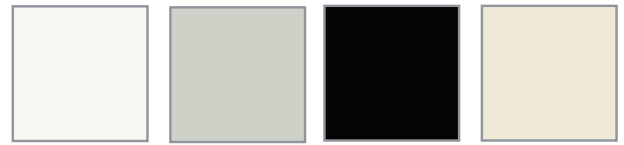

White No. 100    Light Gray No. 101    Black No. 103    Bone No. 104

## LCS Chalkboard Colors



Green    Black    Gray

## Standard Aluminum Trim Color Options



Oyster White RAL1013    Signal Yellow RAL1003    Traffic Orange RAL2009    Red Lilac RAL4001    Signal Blue RAL5005    Moss Green RAL6005    Chocolate Brown RAL8017    Silver Grey RAL7001



Light Ivory RAL1015    Zinc Yellow RAL1018    Ruby Red RAL3003    Claret Violet RAL4004    Cobalt Blue RAL5013    Traffic Green RAL6024    Pale Brown RAL8025    Slate Grey RAL7015



Traffic Red RAL3020    Strawberry Red RAL3018    Ultramarine Blue RAL5002    Violet Blue RAL5000    Sky Blue RAL5015    Leaf Green RAL6002    Signal White RAL9003    Jet Black RAL9005

Also available in over 180 optional powder coat colors

## Standard Matte Finish Trim Colors

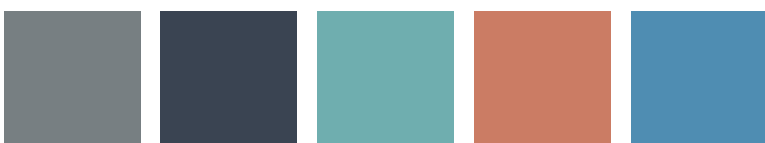

Grey    Slate Grey    Turquoise    Beige Red    Blue



White    Black    Silver    \*Bronze    \*Silver Grey

\*Metallic matte finish

## Edify Trim Colors



Snow    Whisper    Mint



Daffodil    Royal    Crimson

# ACOUSTIC COLORS • FINISHES

---

## Calyx Acoustic Color Options

### Standard Colors (in stock)



Pearl White Marble Steel Graphite

### Additional Colors (for order)



Moondust Bluestone Topaz Sapphire Myrtle Pear Daisy Orange Ruby



Pewter Tiger Eye Camel Quartz Ocean Mist Black Deep Sea Cayenne Moss Stone

---

## MIX Options

### MIX Contemporary Base, Accent Strip & Shelf



Signal White RAL9003  
Slate Grey RAL7015  
Matte Black 302P

### MIX Industrial Base & Shelf



Matte Clear

### MIX Industrial Accent Strip



Matte Black 302P

### MIX Wood Finish Options



Clear Vellum Driftwood Rustic

---

## Wood Finish Options

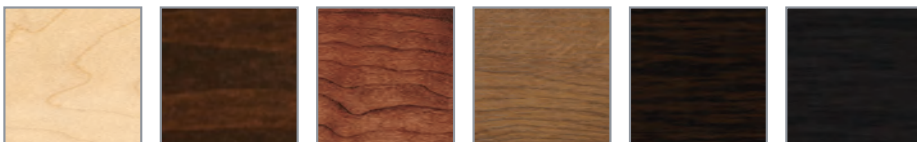

Maple Mahogany Cherry Walnut Espresso Ebony

Custom wood finishes optional

# MATERIALS

## Fabric Options

### Guilford Bailey

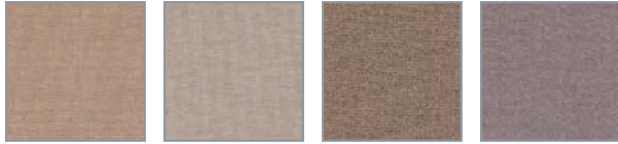

Baxter Beige GB011 Belmont Silver GB010 Khaki GB012 Sherman Pewter GB024

### Guilford Anchorage

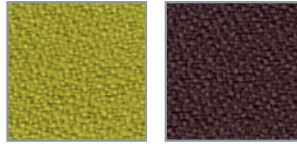

Green Apple GA087 Fossil GA093

### Carnegie Quarry



Stone Manor CQ99

### Maharam Merit

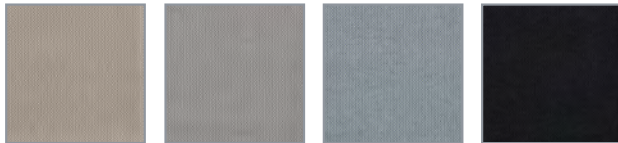

Lynx 028 Overcast 043 Rainfall 009 Blackout 004

### Maharam Meld

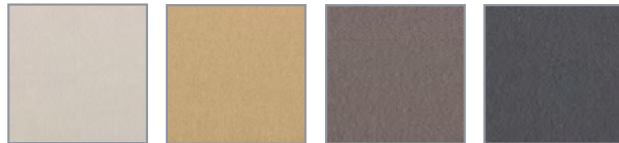

Seashell 012 Blonde 027 Crater 014 Knight 004

### Maharam Manner



Citronella 045 Cottage 023 Dill 043 Nuance 006 Flint 004 Smoky 031 Porpoise 003 Magnetic 032

### Maharam Manner

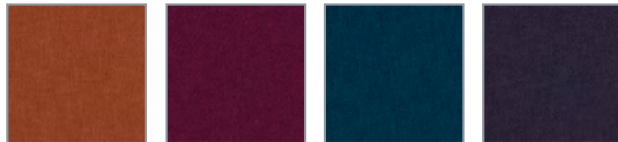

Southwest 047 Kimono 051 Oceanside 040 Valiant 052

## Calyx Cork Options

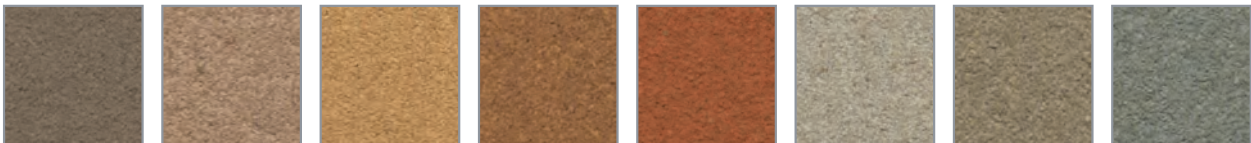

Mushroom 1108 Buff 1109 Fawn 1110 Tan 1100 Cinnamon 1104 Oyster 1103 Smoke 1111 Steel Gray 1113



Graphite 1136 Black 1132 Salsa 1117 Tangerine 1118 Pineapple 1119 Lettuce 1120 Blueberry 1129

Colors are produced with reasonable accuracy.



Crafted *for* collaboration

calyx<sup>™</sup> by Claridge

800.434.4610 | calyxbyclaridge.com

June 2026